

Geodata for the urban environment

Robert Hack

IAEG, Nottingham, 5 September 2006

What is Geodata?

All location dependent data
from:

- Surface, and
- Subsurface

Surface data:

- Climate
- Vegetation
- Land use
- Erosion models
- Etc.

Subsurface data

- Properties of materials
- Material boundaries
- Subsurface processes

Geodata

In short all data that describe the surface and the subsurface of the earth and all processes that have been or are still active to form the materials of the earth.

Geodata in the past

Past:

No design other than the design of the construction based on expertise of the master builder

Past:

- Construction by trial and error
- No idea about fundamentals ground behaviour
- Only the effect on the construction could be seen

Past:

Influence of client (nobility, clergy, powerful landlords, etc.) on location and type of building was very large and in most cases overruling possible technical considerations

Past:

Underground excavations in an urban environment

The catacombs and burial sites in an urban environment: catacombs of Rome (built by trial and error)

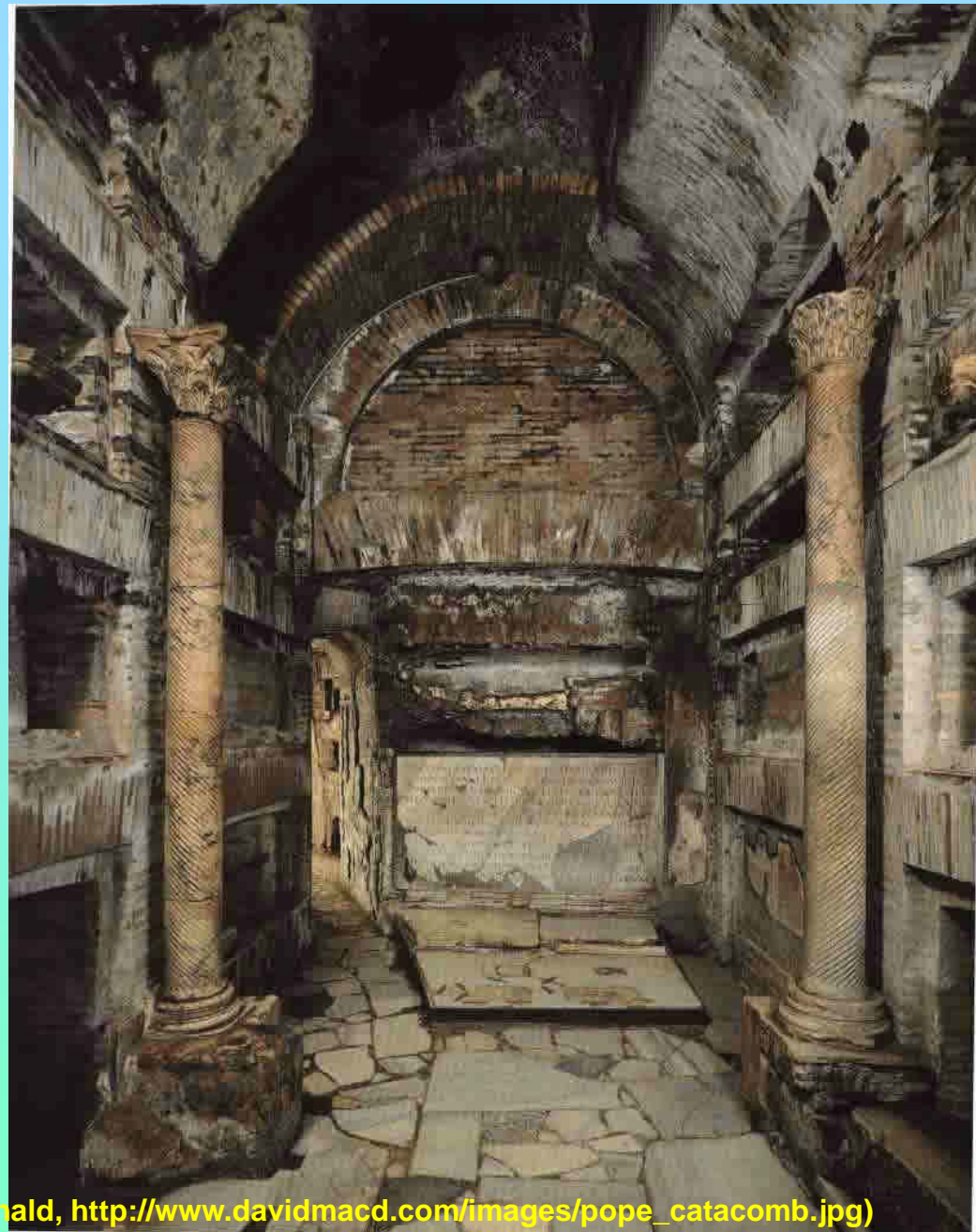

Popes-Catacomb in Rome (photo David MacDonald, http://www.davidmacd.com/images/pope_catacomb.jpg)

Past:

Most underground excavations
for mining
normally not in an urban
environment

Past:

However, mining often provided the chance to gain experience and expertise in

- Ground behaviour, and
- Interaction structure - ground

Past:

During the industrial revolution and thereafter the expertise of miners is a keystone for the development of underground excavations for civil engineering

Also today, I would advice every engineering geologist and geotechnical engineer to work for some time in a mining environment to obtain a decent knowledge on the behaviour of soil and rock masses

Because it is the only place where structures are built with a safety factor of just 1, and which are also intended and allowed to fail over a short time span

Past:

Surface structures

Tower of Pisa (trial and error....)



Tower of Pisa (photo Pisa, 2006)

Oude Kerk, Delft, The Netherlands (trial and error....)



Oude Kerk, Delft, The Netherlands (photo Oude Kerk (Delft), 2006)

For both towers was already during construction found that the subsurface gave excessive differential settlement and the building was adjusted, result:

Pisa a leaning curved tower, Delft a leaning bended tower



Past:

When the “error” was larger
then in the forgoing examples
mostly the structure collapsed

Beauvais Cathedral of Saint Pierre, France - collapsed (in part) 3 times



Cathedral of Saint Pierre, Beauvais (photo Allen et al., 2003)

Beauvais Cathedral, France

Remaining part also today under threat of collapse due to differential settlement in the subsurface and structural weaknesses in the construction



(photo Allen et al., 2003)

In the past:

- Expertise of the master
- Trial and error
- No idea about fundamentals of ground behaviour
- Only the effect of the ground behaviour on the construction could be observed
- Transfer of knowledge on ground behaviour and geodata by system of “master and apprentices”
- Strong influence of the client

At present (1):

Past: Expertise of the master

Present: Although not called a master the chief engineer is still important

Past: Trial and error

Present: “normally” avoided by using modelling and testing

At present (2):

Past: No idea about fundamentals of ground behaviour

Present: Since the last ½ century large development of knowledge

Past: Only the effect of the ground behaviour on the construction could be observed

Present: Plenty of monitoring options of the ground itself

At present (3):

Past: Transfer of knowledge on ground behaviour and geodata by system of “master and apprentices”

Present: the same but also universities and schools, written and printed documents, and recently internet

Past: Strong influence of the client

Present: the same, but more “hard” technical documentation available to convince client if his wishes may not be “logical”

Future:

Is geodata going to be **required**?

Is **more** geodata going to be required?

Is **other** geodata required than at present?

Can the **ease of use** of geodata be improved?

Can geodata be made more **credible**?

Use of the subsurface

- More emphasis on environmentally more sound forms of infrastructure (hence underground)
- Shortage of space will require more use of the underground
- Power stations (for example, nuclear power stations) underground
- Storage of energy
- Storage of waste
- Geoenergy

More and more structures and infrastructure underground which will increase the demand for geodata

- More structures and infrastructure underground means more competing uses of the underground
- More complex relations and influences between different uses of the underground
(for example, it is not nice if your neighbor installs a geoenery storage installation just besides your wine cellar)

more use will also require:

- Protection of sites (for example, archeological etc.)
- Geological special sites (for example, type sections)

More use of the underground is without doubt going to lead to

- more subsurface related disasters, and
- destroying of valuable underground features

Future:

Is geodata going to be **required**?

YES

Is **more** geodata going to be required?

YES

Is **other** geodata required than at present?

Can the **ease of use** of geodata be improved?

Can geodata be made more **credible**?

Are other types of geodata required?

More intensive underground use will require more data on:

- Time effects
- Heat flow/isolation capacity

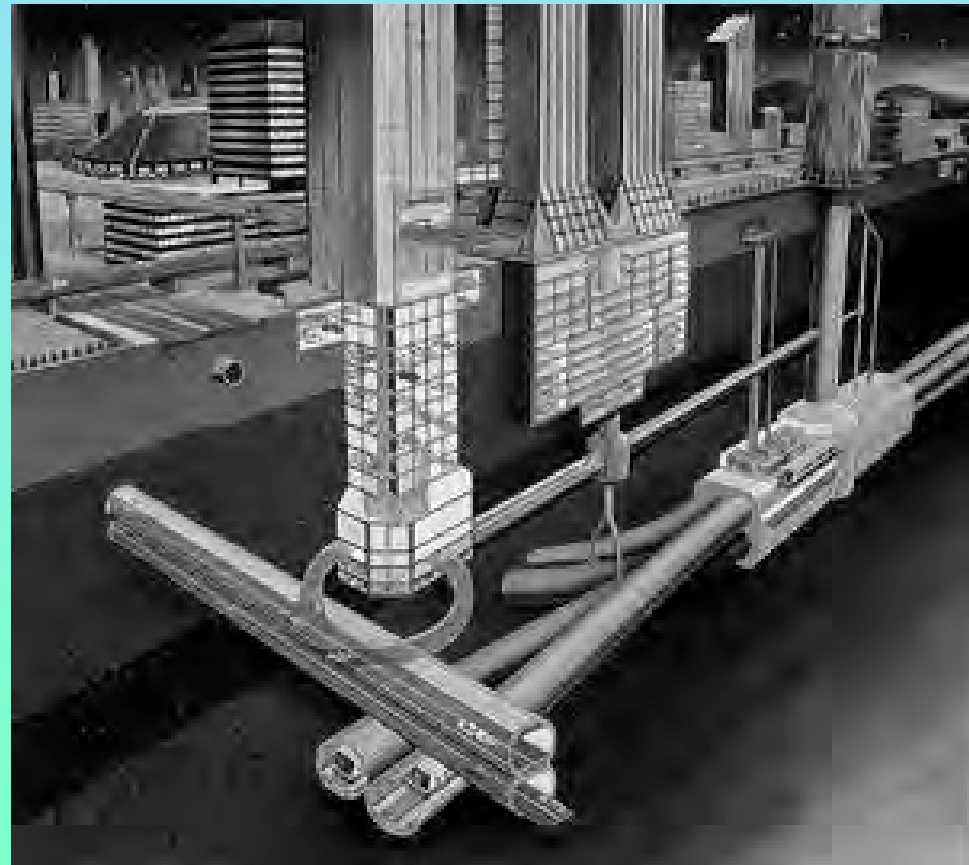

Time effects:

- “Walking” pipelines and tunnels
- Degradation of material under influence of vibrations or pressure

Heat flow/isolation capacity of ground:

- How well does the ground isolate fires?
- How are the ground properties influenced by a fire?



Heat flow/isolation capacity of ground:

- How do ground properties change or degrade under influence of repeating cycles of temperature changes (geoenergy storage)
- How well does the ground isolate? (your wine cellar neighbouring a geothermal energy storage!)
- Etc.

Future:

Is geodata going to be **required**?

YES

Is **more** geodata going to be required?

YES

Is **other** geodata required than at present?

YES

Can the **ease of use** of geodata be improved?

Can geodata be made more **credible**?

Ease of use and credibility:

- Invisibility of the subsurface
- High “hocus-pocus” level and the vagueness of many geological or geotechnical advices caused by:
 - The complexity of underground data
 - The complex relations and processes in the subsurface

In addition:

- The often high degree of uncertainty
- The impossibility to quantify the uncertainty

Invisibility

Visibility improves day-by-day:

- 3 and 4 dimensional GIS
- High-level of 3 and 4 dimensional visualization of the subsurface

Is not (yet) perfect but rapidly improving in quality

Allows also non-experts to get a better idea on the geodata of the subsurface

(and to understand why it is important)

Example: Open pit and underground mine (GoCad, Nancy)

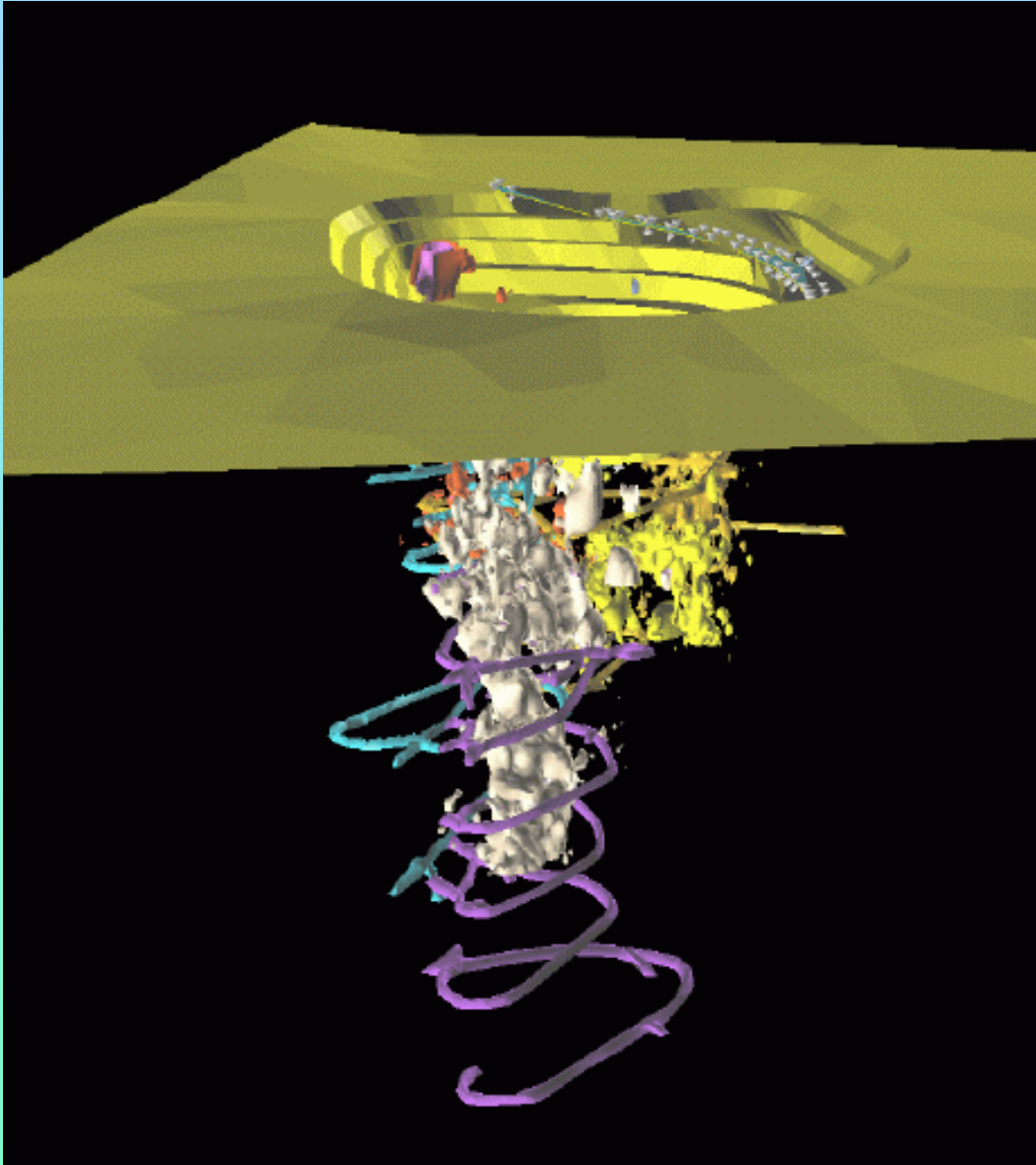

Example: oil reservoir (GoCad, Nancy)

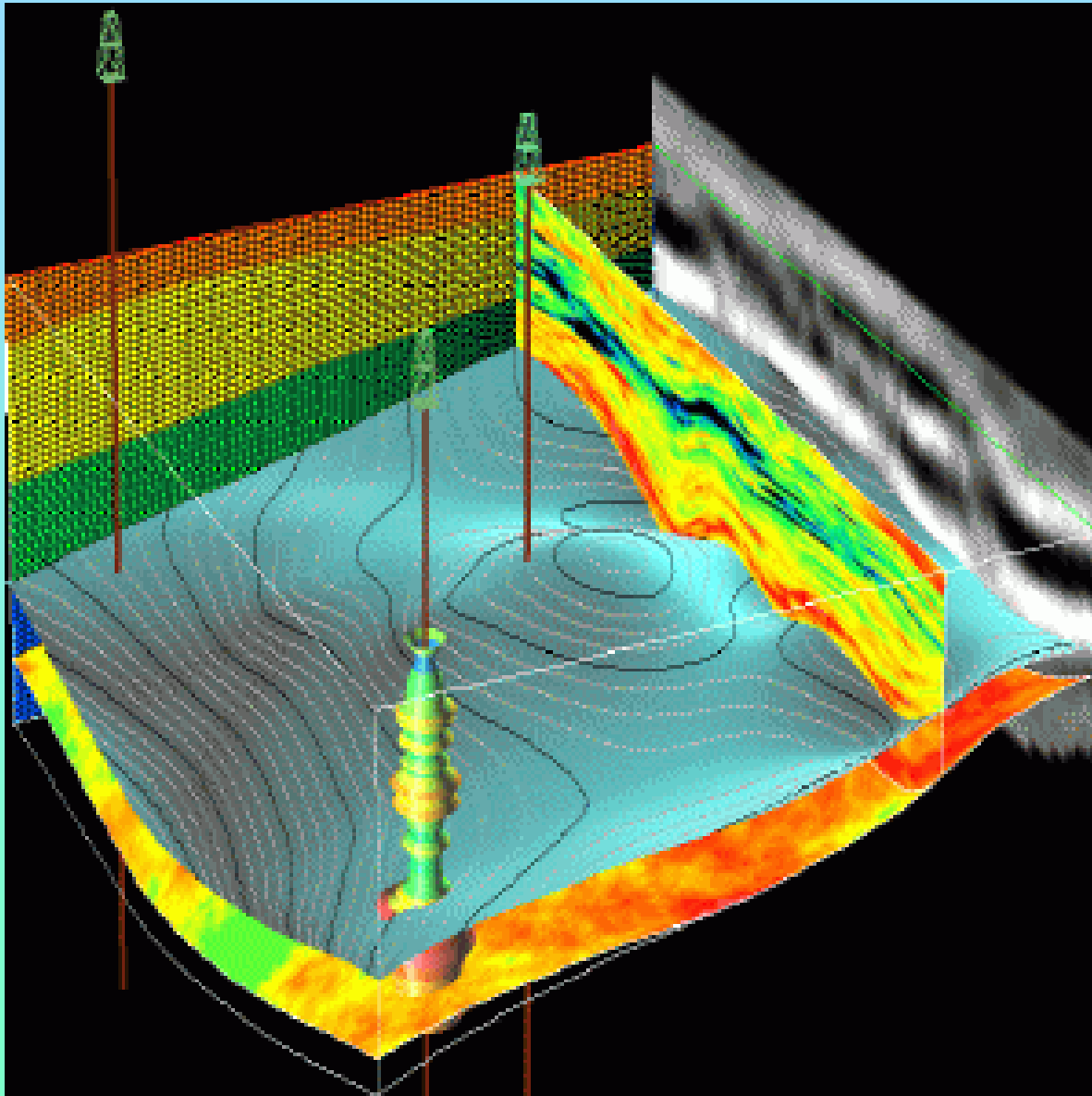

Example: Heinenoord tunnel geodata model (ITC)

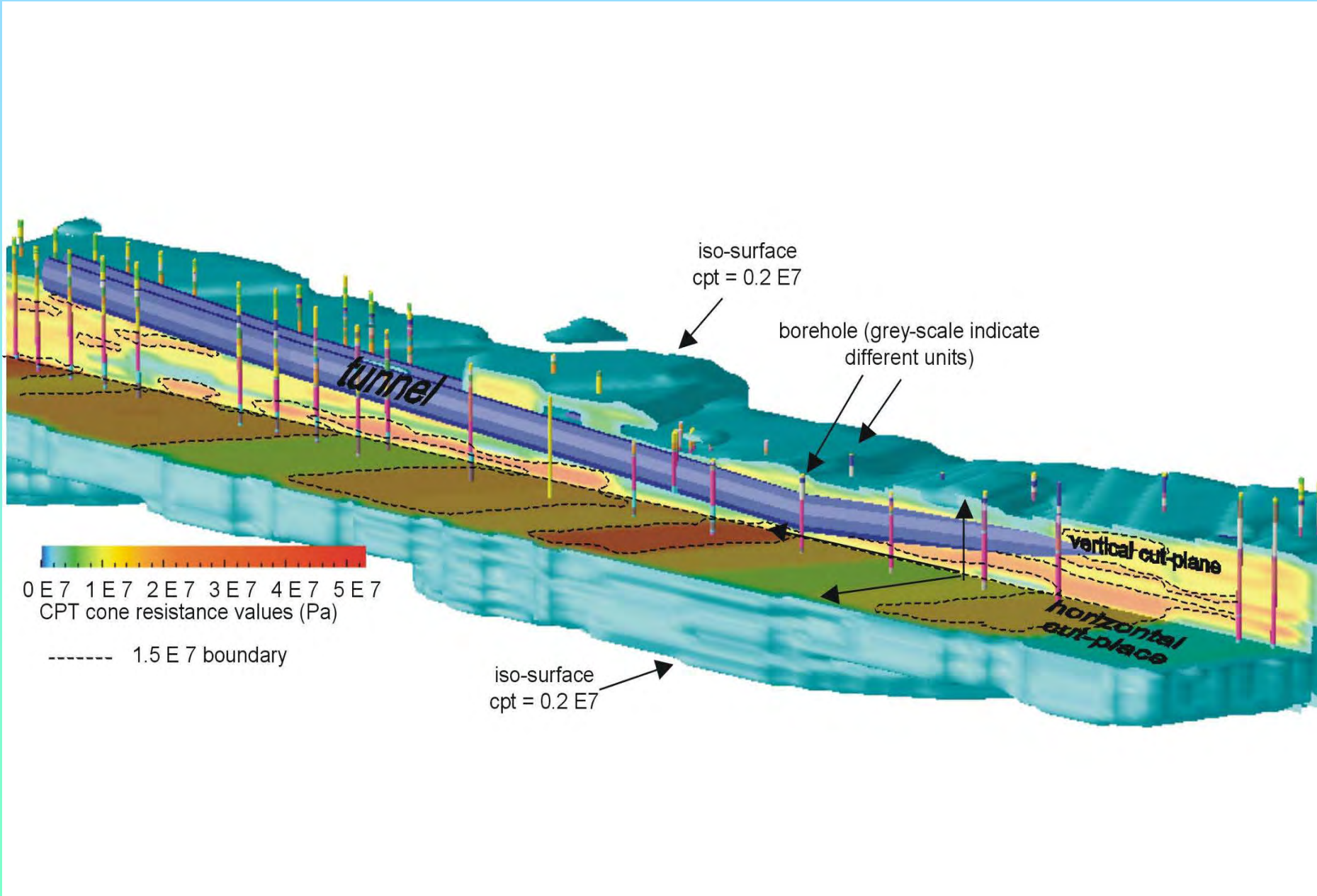

Example: Settlement model for possible housing area

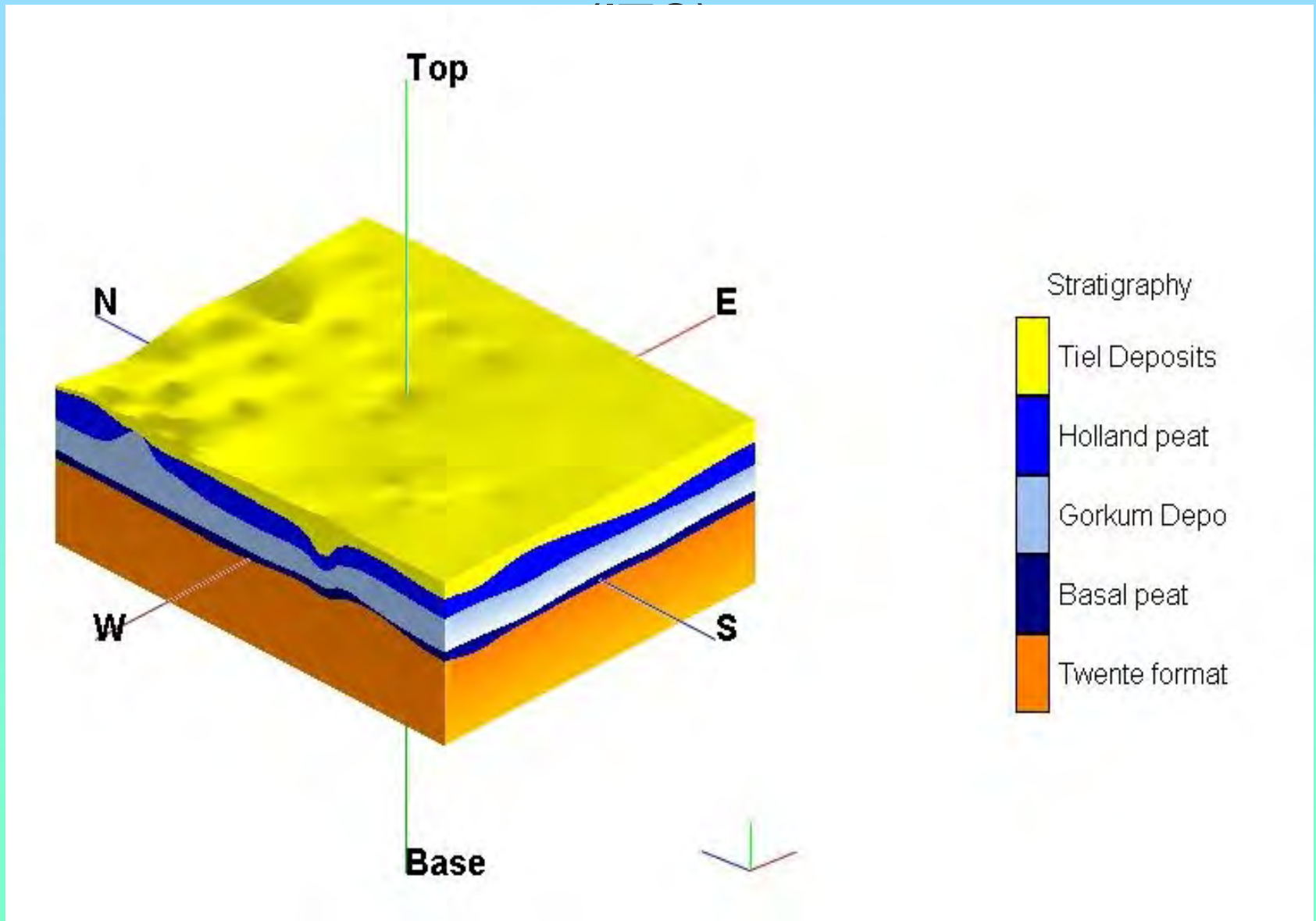

Complexity of subsurface geodata

What are the data:

- Unit boundaries
 - Properties and distribution of properties
 - (complicated) Constitutive models for material behavior (e.g. stress-strain-temp, etc.)
 - Interaction between different uses
 - Water and gass data
 - Historic data on mining or other subsurface activities
 - Archeological data
 - Etc., etc.
- (and all the interactions between them)

In addition: at present:

- Data stored in various repositories (e.g. geological survey, consulting engineer offices, cadastre, etc.)
- Data on paper and in digital format
- Digital data in raster and vector format
- Many different formats of digital data
- Digital formats often program (application) specific
- Exchange between formats difficult
- Etc. etc.

Solution:

Better standards for engineering geology and geotechnical data

Research required:

- Meta-format definitions
- Model exchange formats

Uncertainty of subsurface data and models

Example: Heinenoord tunnel

(balanced earth pressure shield bored tunnel in soft sediments near Rotterdam, Netherlands)

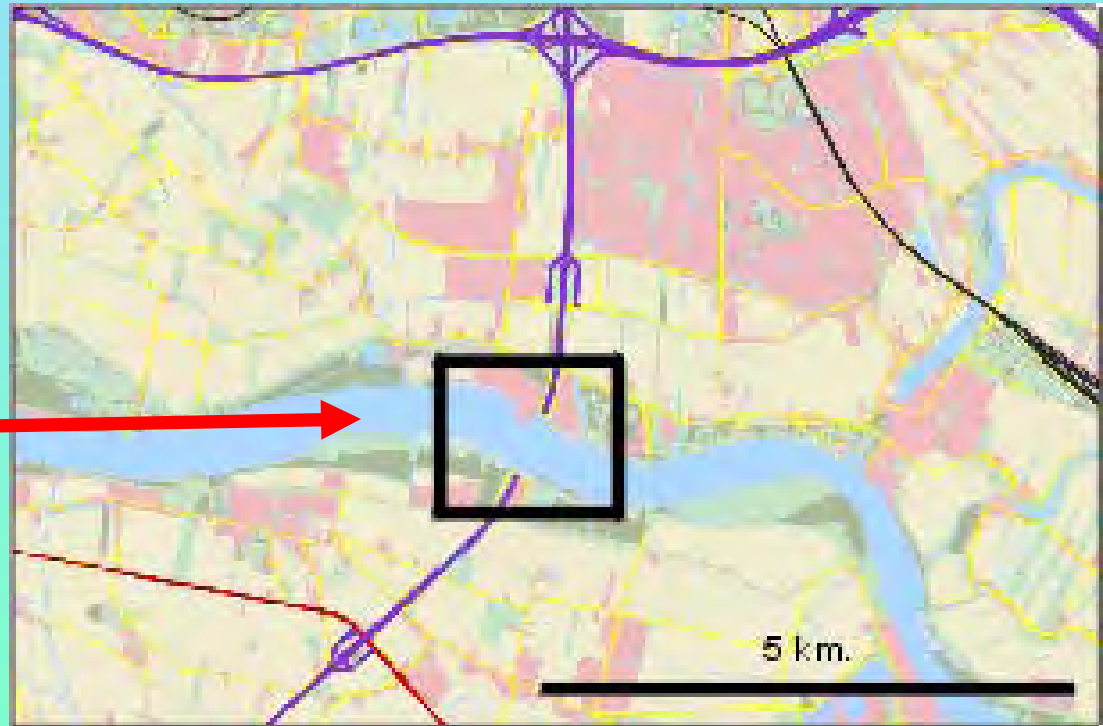
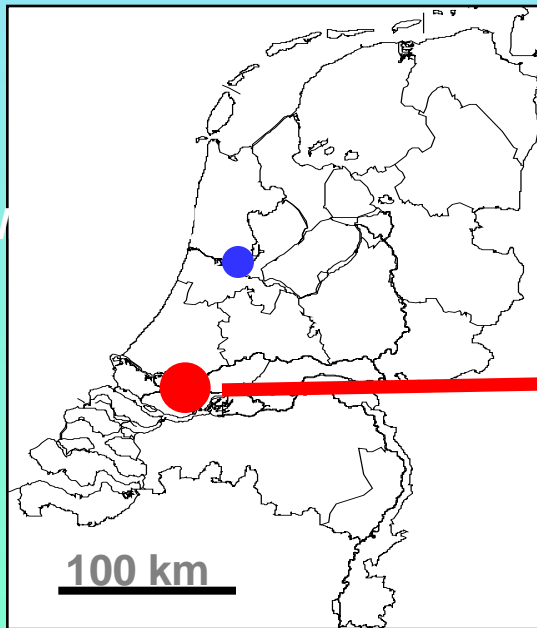

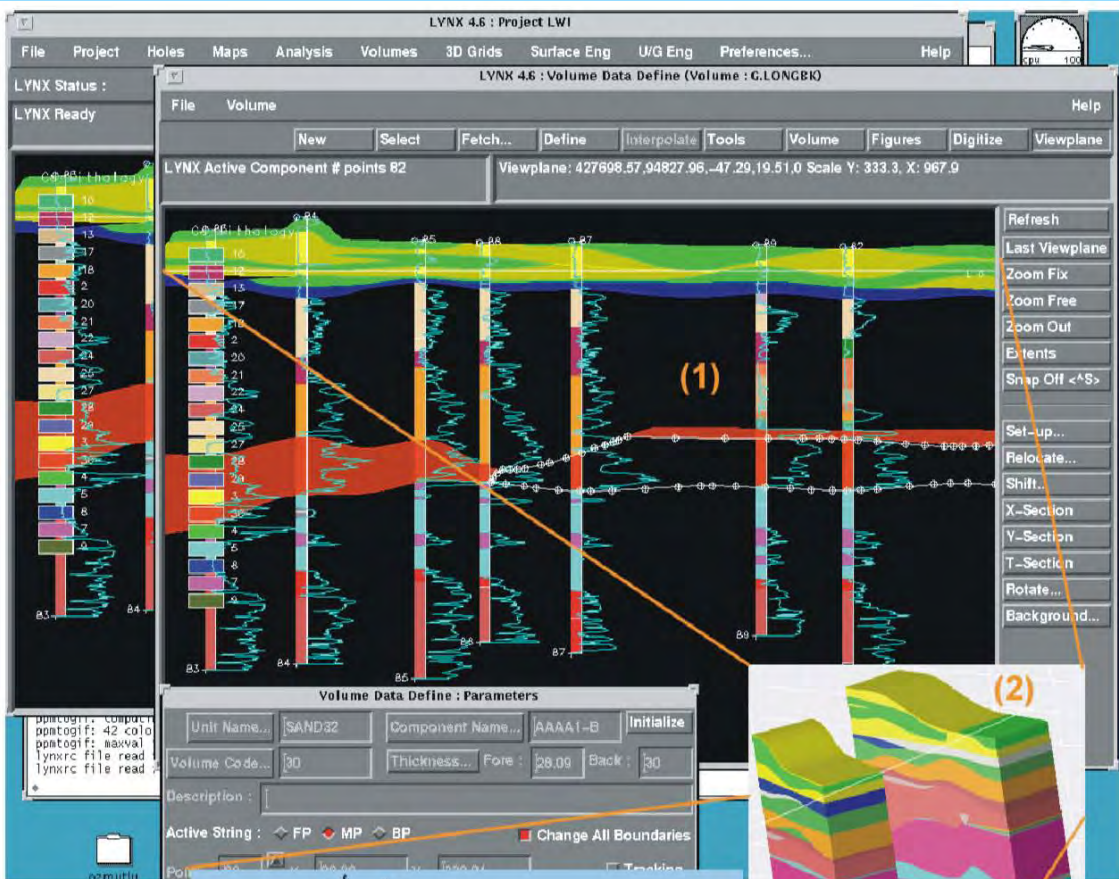

Heinenoord tunnel (2)

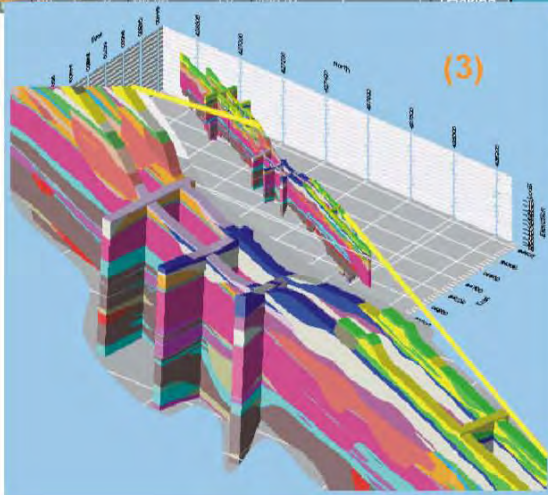

Heinenoord tunnel

large area
low detail

smaller area
more detail

smallest area
highest detail

Each color indicates
a different layer with
different material,
properties, etc.

Heinenoord tunnel (4)

Strength (Cone Penetration Test) model

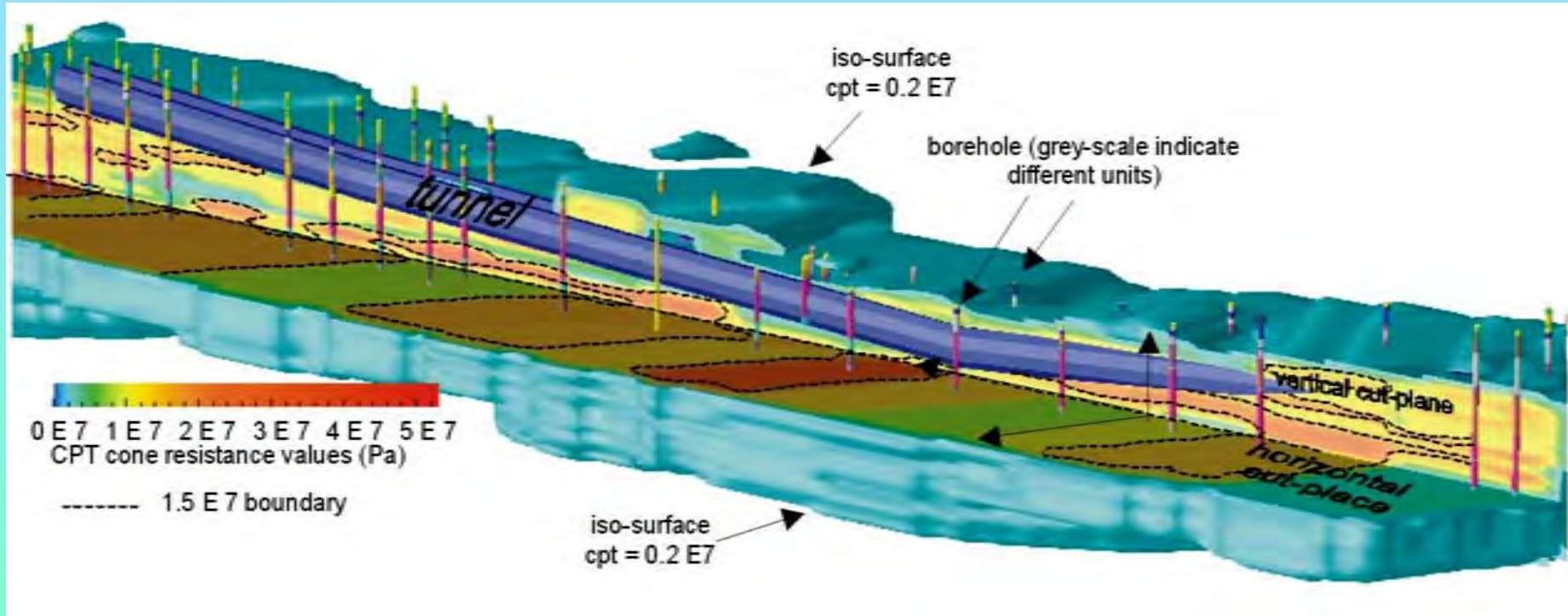

(Heinenoord Tunnel, Netherlands)

Interesting model, but what does it actually show:

A series of boundaries arbitrarily drawn by a qualified engineering geologist or geotechnical engineer
(or at least that is what we hope)

and

A statistical analysis of a ground property
(hopefully the correct analysis within the correct boundaries)

The example did not show
anything about:
the quality of the model nor of
the correctness of the prediction

The ground model can be:

- total nonsense or,
- completely correct, or
- anything in-between.

Too few data to be able to describe the subsurface exactly and hence:

Expert knowledge is used to model the subsurface geology

Expert knowledge

or

Geo-fantasy

Is there a way to establish the quality of
an interpretation;
e.g.
expert knowledge
versus
geo-fantasy?

Boundaries were drawn because the subsurface is not everywhere the same, e.g. it is inhomogeneous

What is inhomogeneity:

For example:

- an intact rock strength variation within a block of intact rock material causes the intact rock material to be inhomogeneous
- a variation in porosity in a clay causes a clay layer to be inhomogeneous
- a variation in the orientation of discontinuities (e.g. jointing) causes a rock or soil mass to be inhomogeneous

Any design of a civil engineering application on or in the subsurface requires the division of the subsurface in “**homogeneous**” units to be able to make calculations of, for example, bearing capacity, settlement, etc.

Geotechnical unit:

A “geotechnical unit” is a unit in which the geotechnical properties are the same.

geotechnical units are based on the experience and expertise of the interpreter

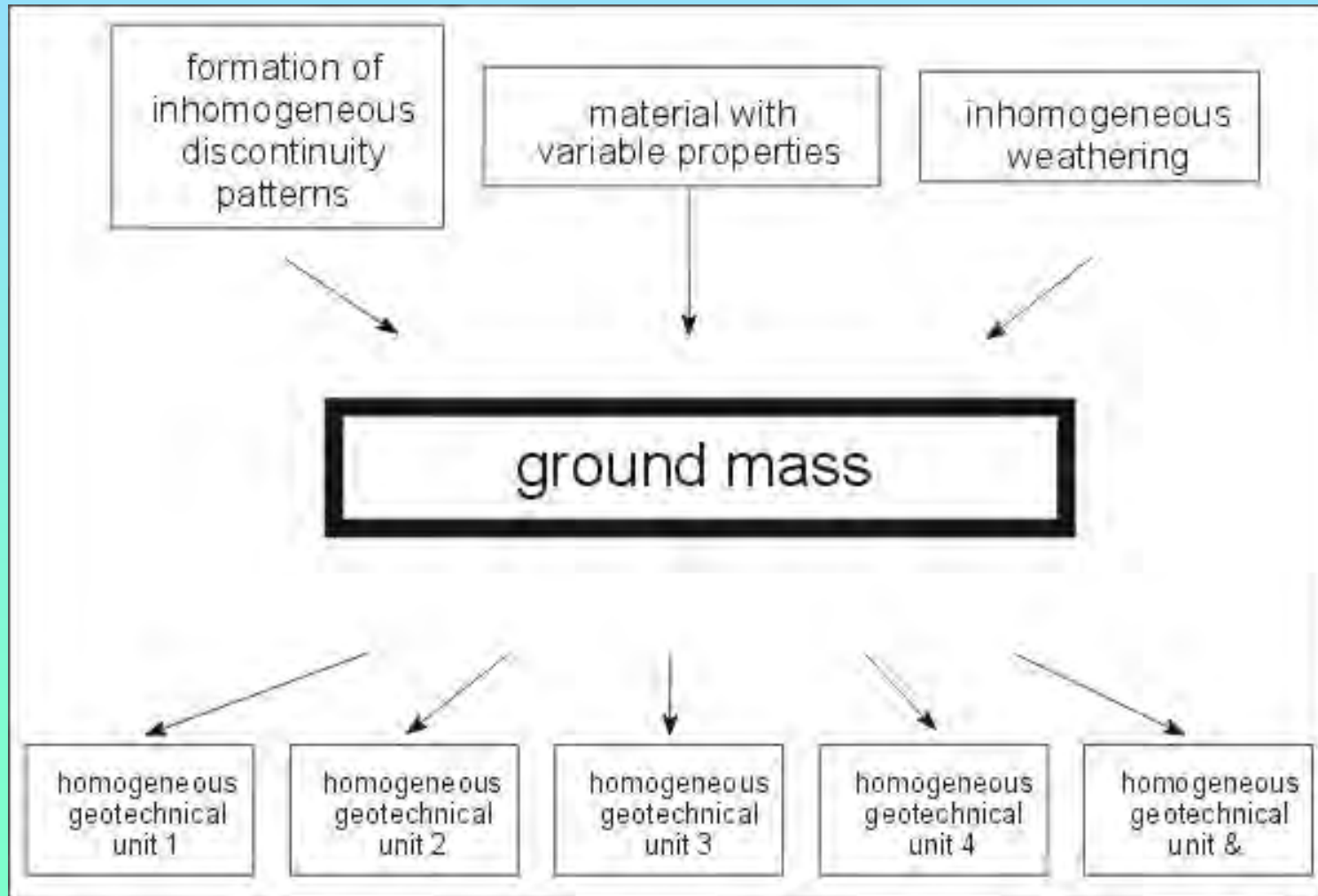

**“No geotechnical unit is really
homogene....”**

A certain amount of variation has to
be allowed as otherwise the number
of units will be unlimited

“The allowable variation of the properties within one geotechnical unit depends on:

- 1) the degree of variability of the properties within a mass,
- 2) the influence of the differences on engineering behaviour, and
- 3) the context in which the geotechnical unit is used.

Smaller allowed variability of the properties in a geotechnical unit results in:

- higher accuracy of geotechnical calculations
- less risk that a calculation or design is wrong

Smaller allowed variability of the properties in a geotechnical unit:

- requires collecting more data and is thus more costly
- geotechnical calculations are more complicated and complex, and cost more time

Hence:

- the variations allowed within a geotechnical unit for the foundation of a highly sensitive engineering structure (for example, a nuclear power station) is smaller
- the variations allowed within a geotechnical unit in a calculation for the foundation of a standard house will be larger

Original situation



design error

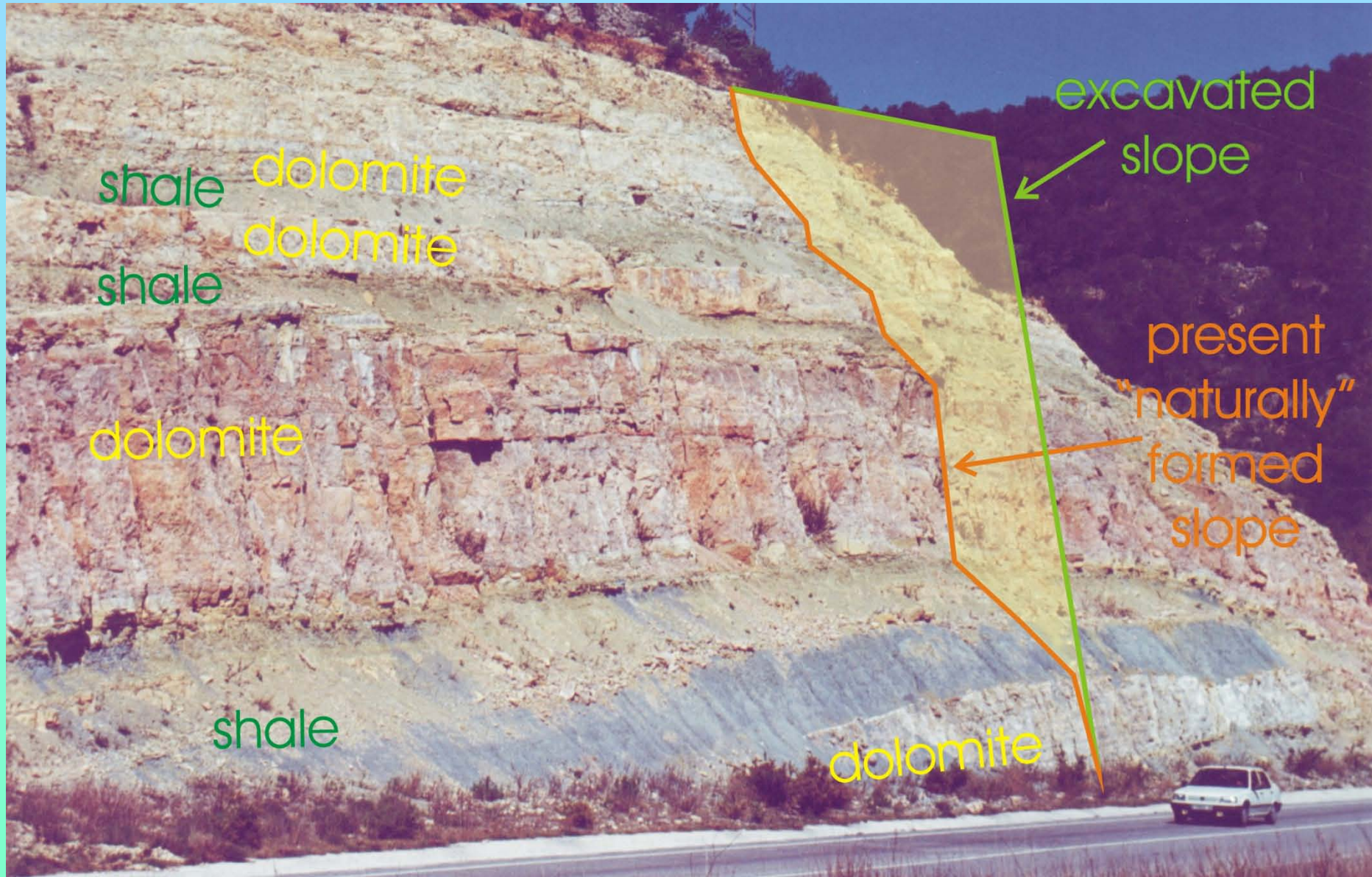

What can go wrong if the geological model is too much simplified with too few units

Heinenoord tunnel

large area
low detail

smaller area
more detail

smallest area
highest detail

Each color indicates
a different layer with
different material,
properties, etc.

Heinenoord tunnel

- Highly detailed geology model was made **after** the tunnel was finished.
- Subsurface geology model used for design consisted of a simplified model with 4 - 6 different units because the calculation model became too complex if more different units were used

Heinenoord tunnel

- Major problems during construction due to blow outs
- Project delayed by many months
- Difficult to prove but problems with boring such as blow outs, would probably have been anticipated if not a too rigorously simplified subsurface model was used

Many more examples can be given of civil engineering structures in rock or soil masses that resulted in problems because:

- geological interpretation was wrong
- variation in properties was not recognized
- variation was not incorporated properly in geotechnical calculations

More data could solve this

Simple to state, but nobody is prepared to pay for it

Alternative: Quantify likelihood of subsurface models

Two items:

- a) Data itself – relatively easy (e.g. statistics)
- b) Expert knowledge (“expertise”) used for interpreting the data – difficult

Two examples:

- **Regional Scale:**
 - sparse data
 - poor quality of resulting 3d model
 - North Sea Seafloor Pipeline project

- **Site Scale:**
 - dense data
 - good quality of resulting 3d model
 - Reeuwijk Road/housing area

North Sea Seafloor Pipeline project

Project question:

- how much sand is available to bury the pipeline in, and
- how reliable is the thickness at any location

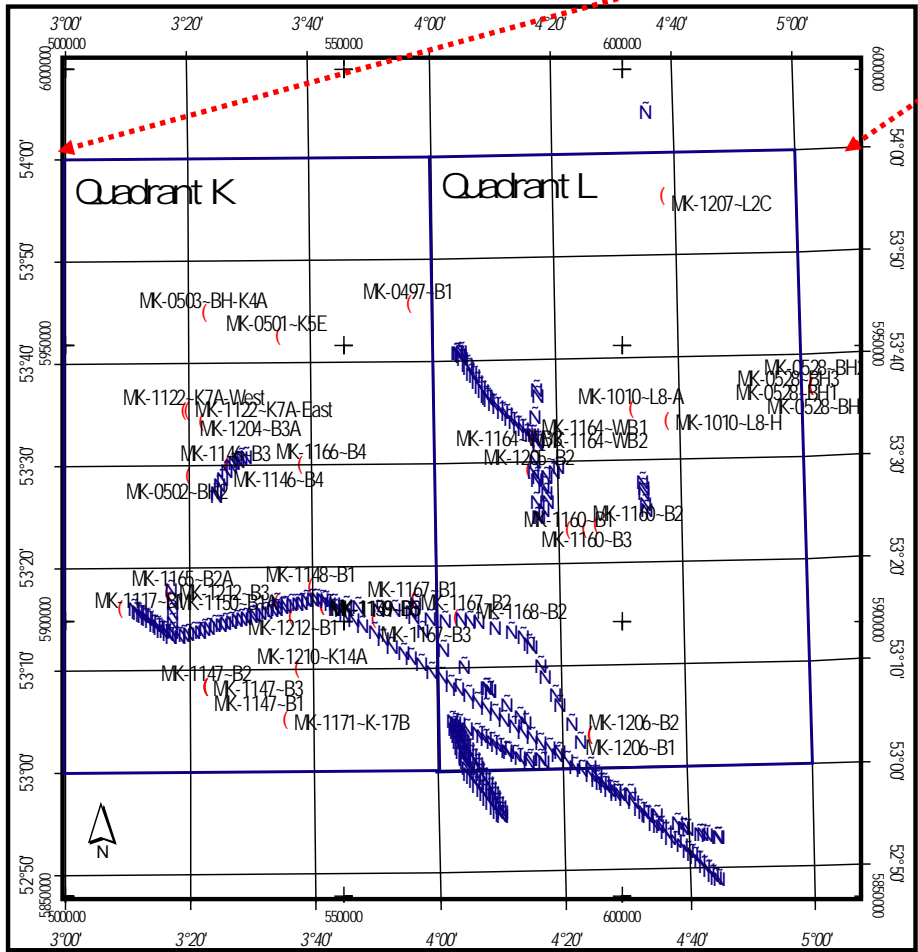

N Shallow holes
(Deep holes

10000 0 10000 20000 30000 Meters

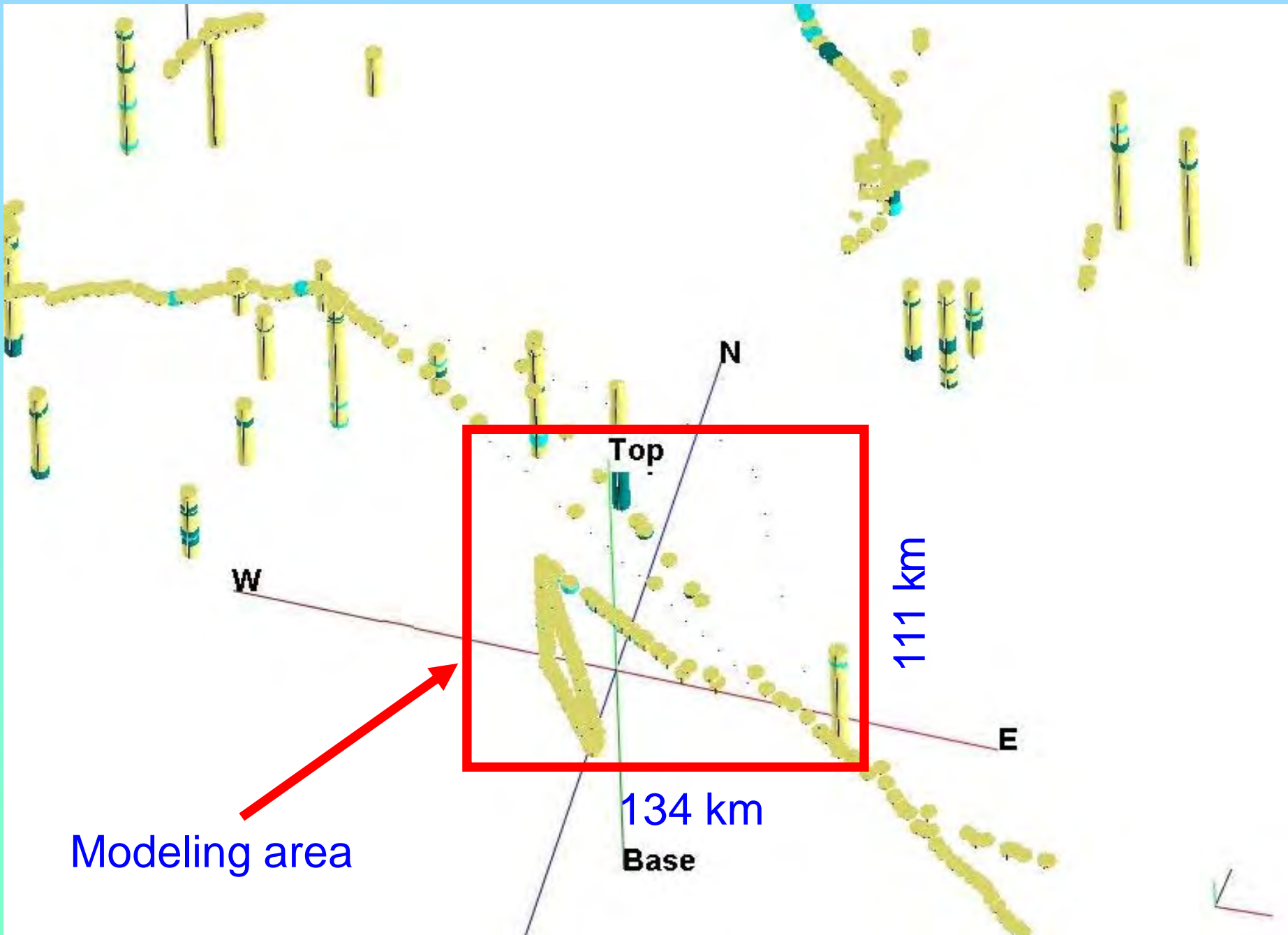

Modeling area

Top

111 km

134 km

Base

Model A: five units

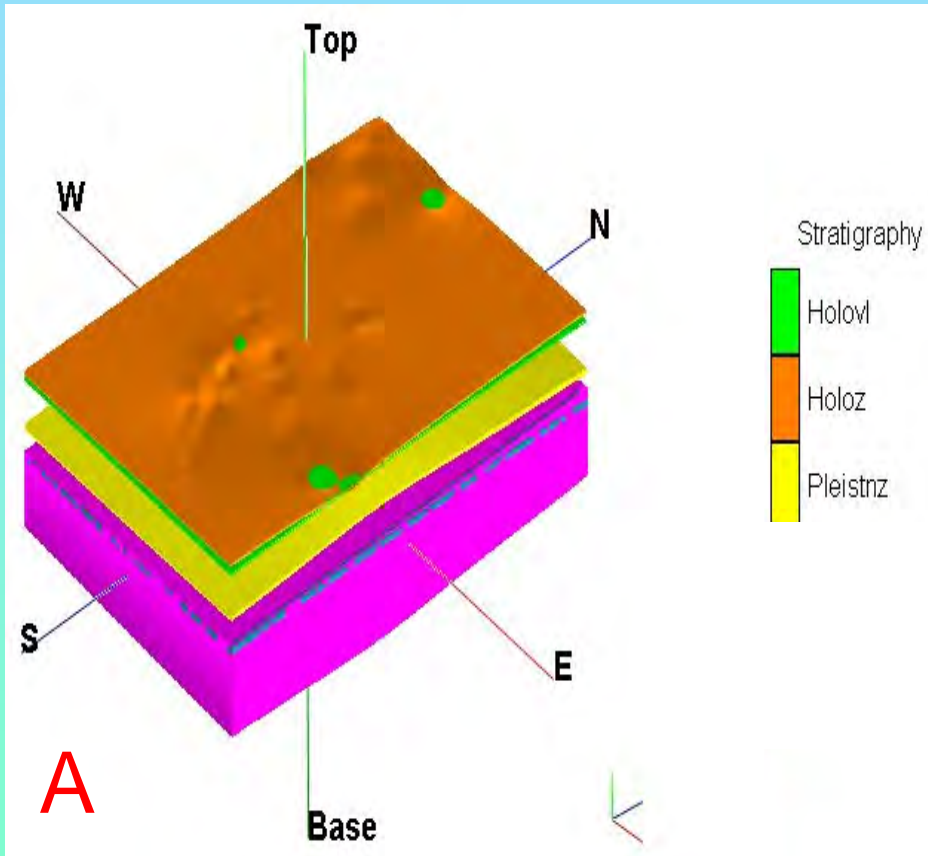

Model B: four units

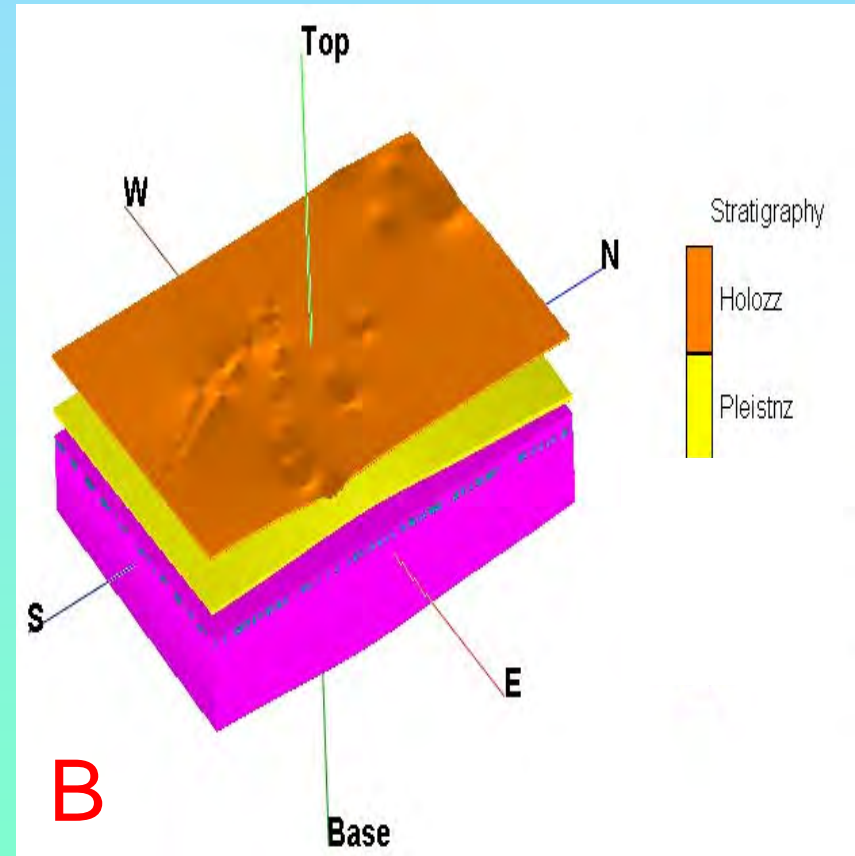

Pipeline model

Model is robust – changes in sand volume are small if modeled with different number of units - meaning:

- interpretation has limited influence
- more data will virtually not improve the quality of the required data, e.g. the sand cover thickness,
- more data will only marginally improve the reliability of the model

Pipeline model

Model is suitable for its purpose

Case Study – Reeuwijk Road Project

Project question:

how much settlement can be expected for a road alignment

(Reeuwijk area in the Western part of the Netherlands is known for extensive layers of peat that can give excessive amounts of settlement, in particular a problem for urban planning)

Case Study – Reeuwijk Road Project

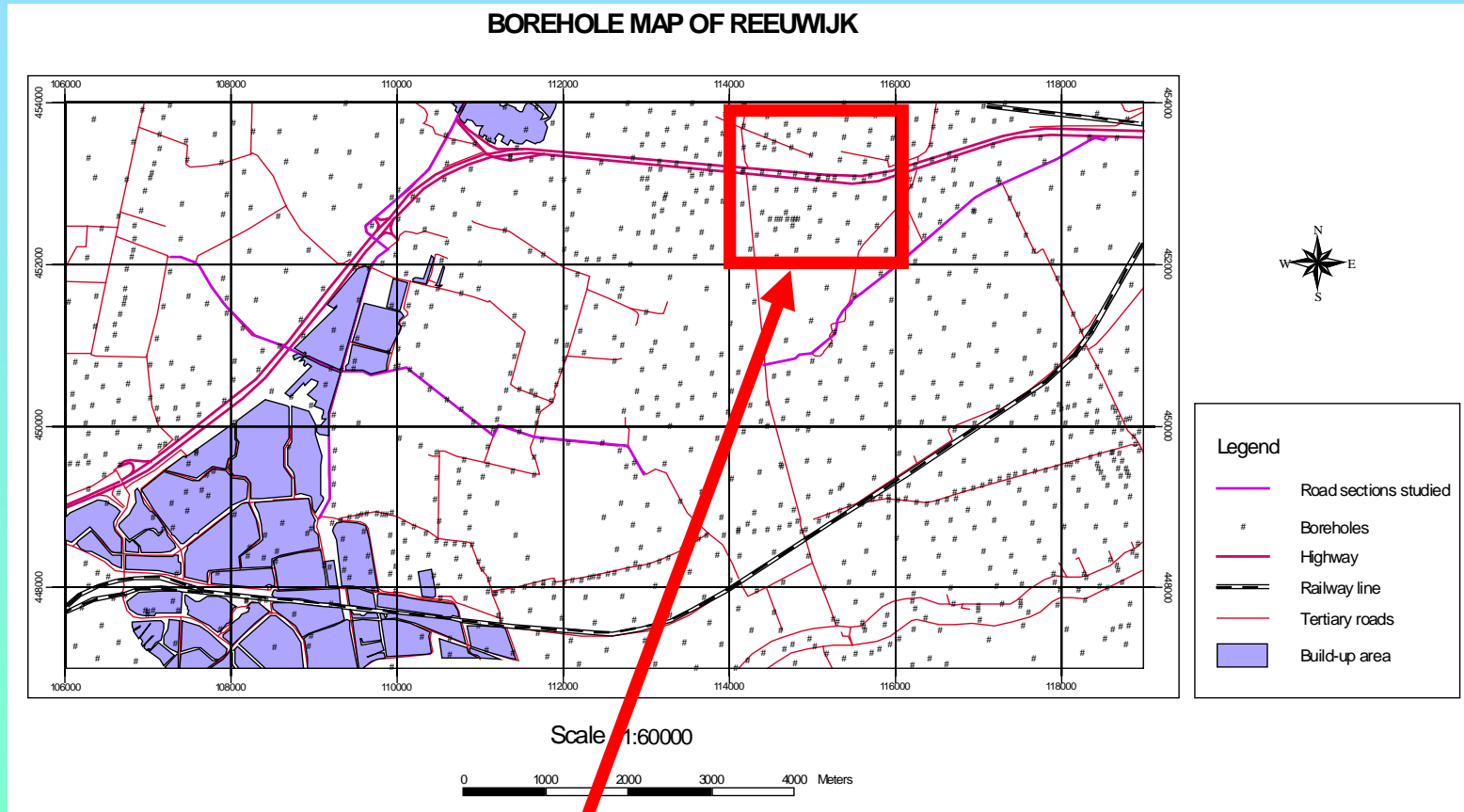

A small area of 3.2 km² with 63 shallow boreholes

Conventional “hand” - interpreted section

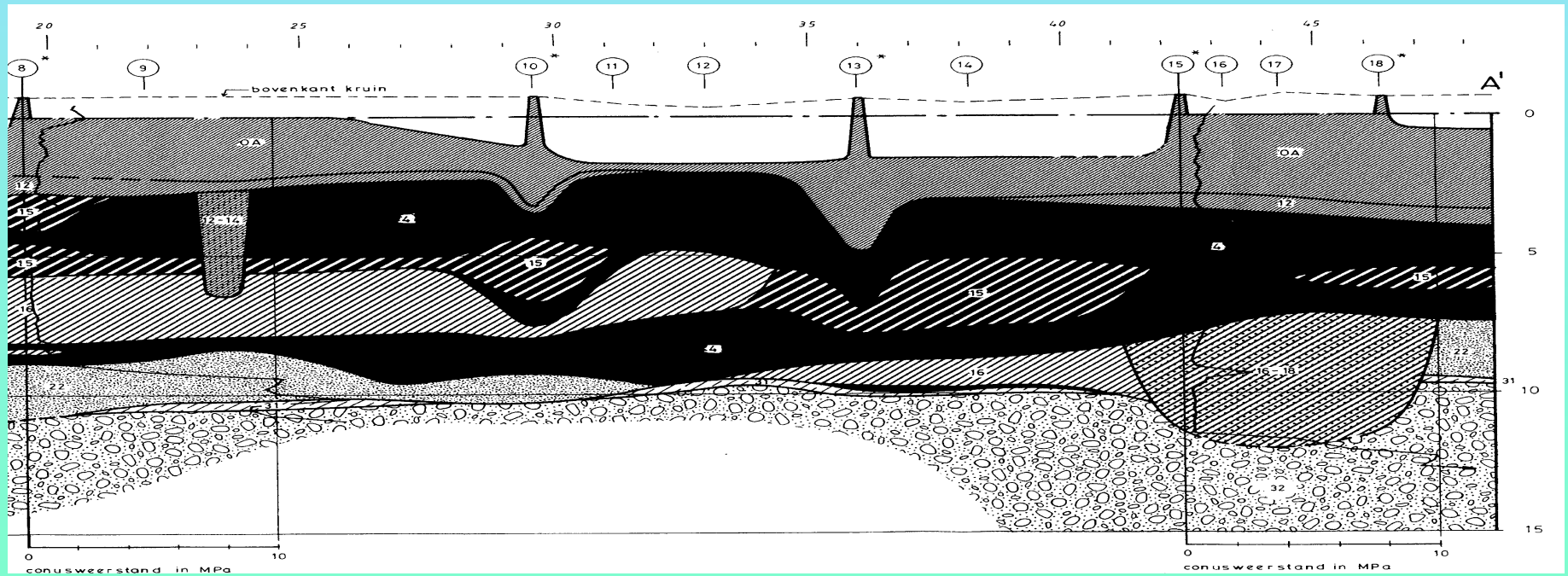

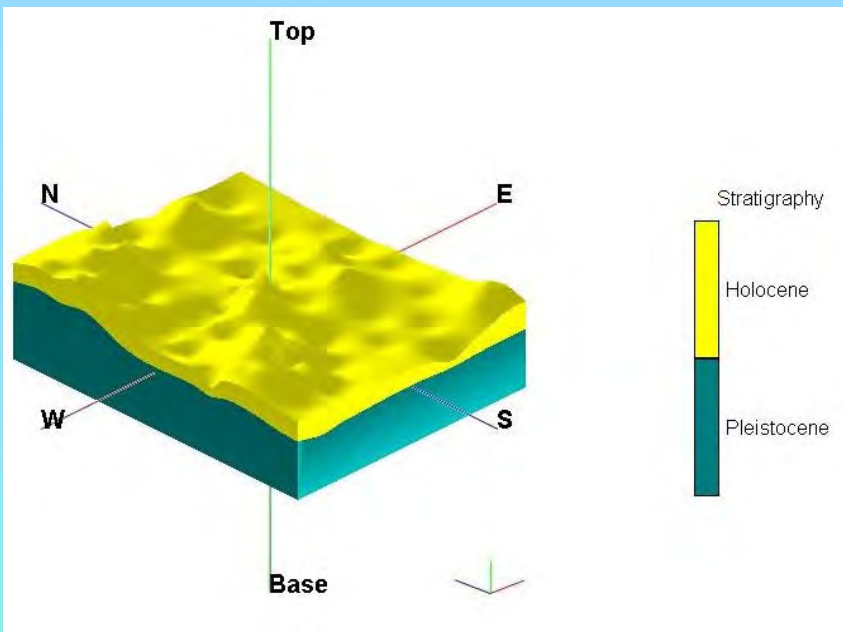

Model 1: two units

Holocene unit (top)

Twente Formation (sand)
(bottom)

Model 2: three units

Upper Holocene (top)

Lower Holocene (intermed.)

Twente Formation (bottom)

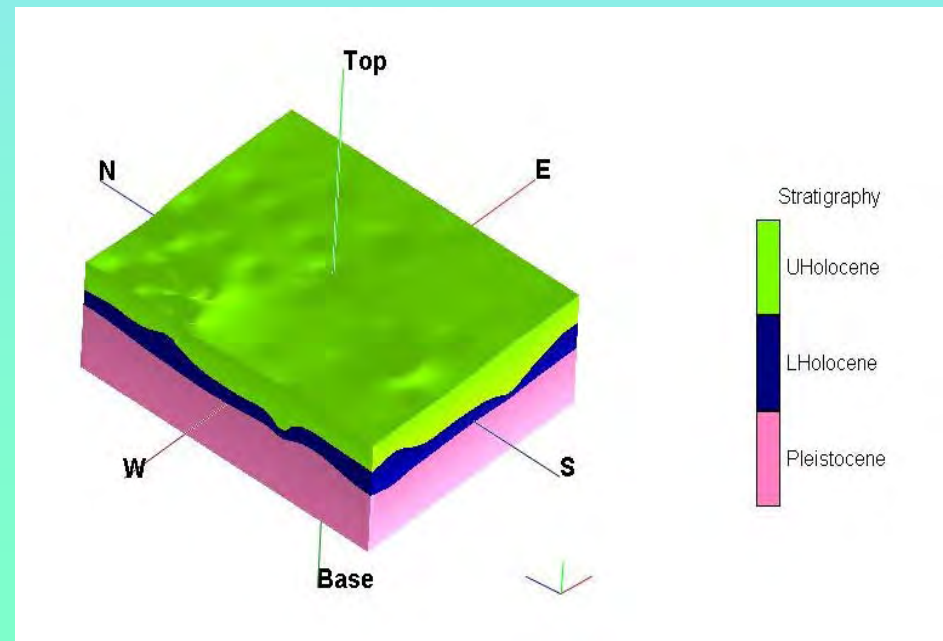

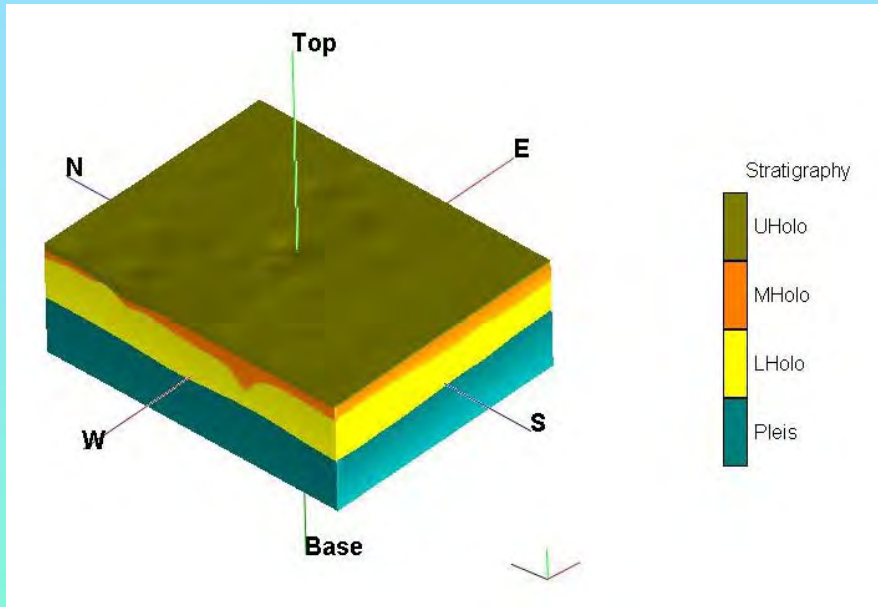

Model 3: four units

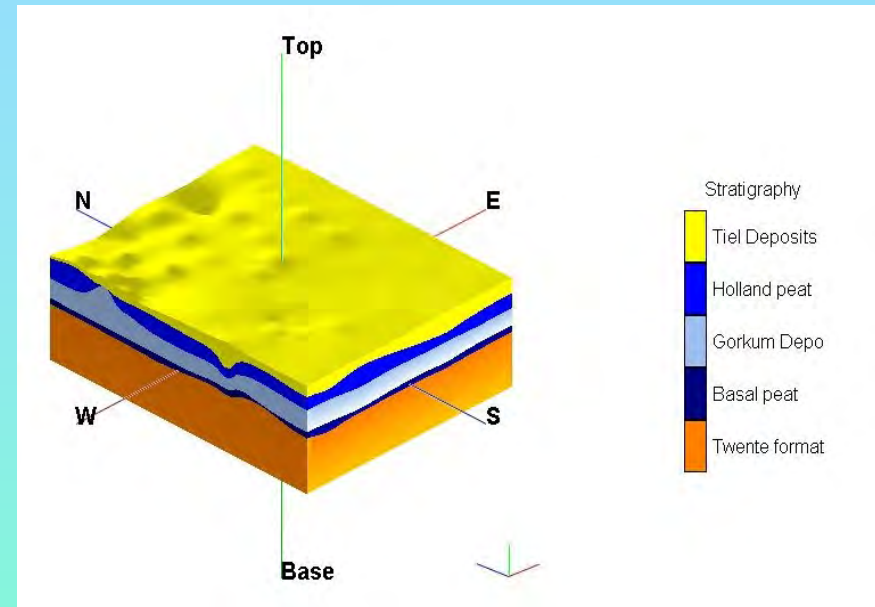

Model 4: five units

Reeuwijk project:

Large area (planning):

- model (relatively) robust and thus suitable

Small area (design):

- model not robust, e.g. unreliable, and thus not suitable

Likelihood model

- Create a geological knowledge based system for reasoning of geological information
- Integrate knowledge-based interpretation into 3d modeling system
- Model likelihood index based on data quality, interpretation level, and model algorithm selection

Modeling Process

- Analyze the known data and information (geological, geotechnical, etc.)
- Build geological knowledge base system for reasoning of geological information used for interpretation

Examples:

- flowchart to interpret Pleistocene sand unit (Twente Formation)
- Spain slope

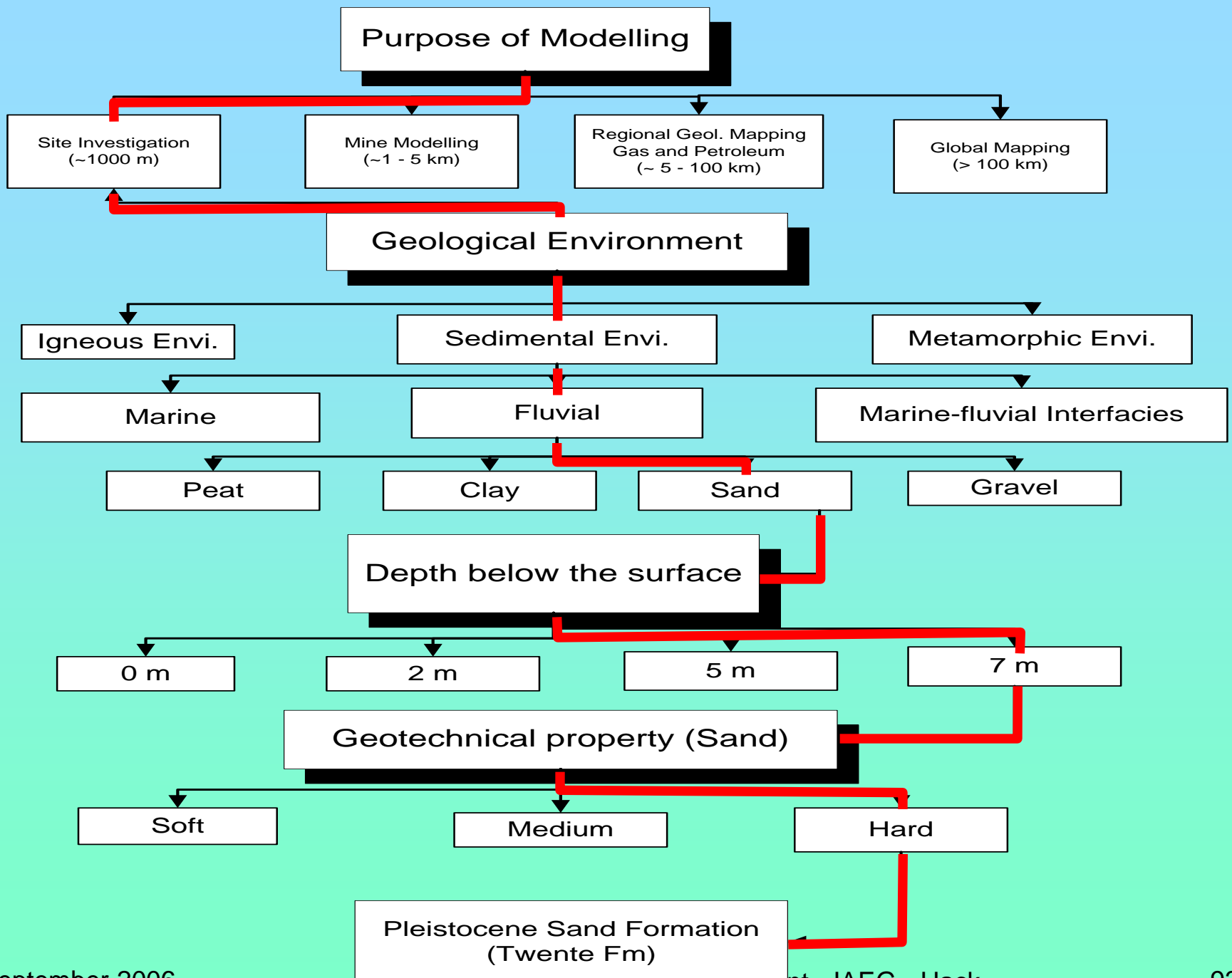

The result of the flow model is coupled to the borehole and CPT information

which

gives the data points for the boundary of the Pleistocene sand which can then (automatically/geostatistically) be interpreted

Advantages (theoretical):

- The flow scheme is generic and can be analyzed by multiple geologists on correctness
- Using the flow scheme will always result in similar interpretation of boreholes and CPT and resulting (Pleistocene) boundary

hence:

The interpretation of the borehole logs and CPT and the resulting Pleistocene boundary become independent from the interpreter

In practice:

- In geological relatively simple areas it works
- In geological more complicated areas many more rules are required
- Not all rules in geology are very clear – often geological knowledge on geological processes that formed the subsurface is only defined in very general qualitative terms – this needs further research and quantification

design error

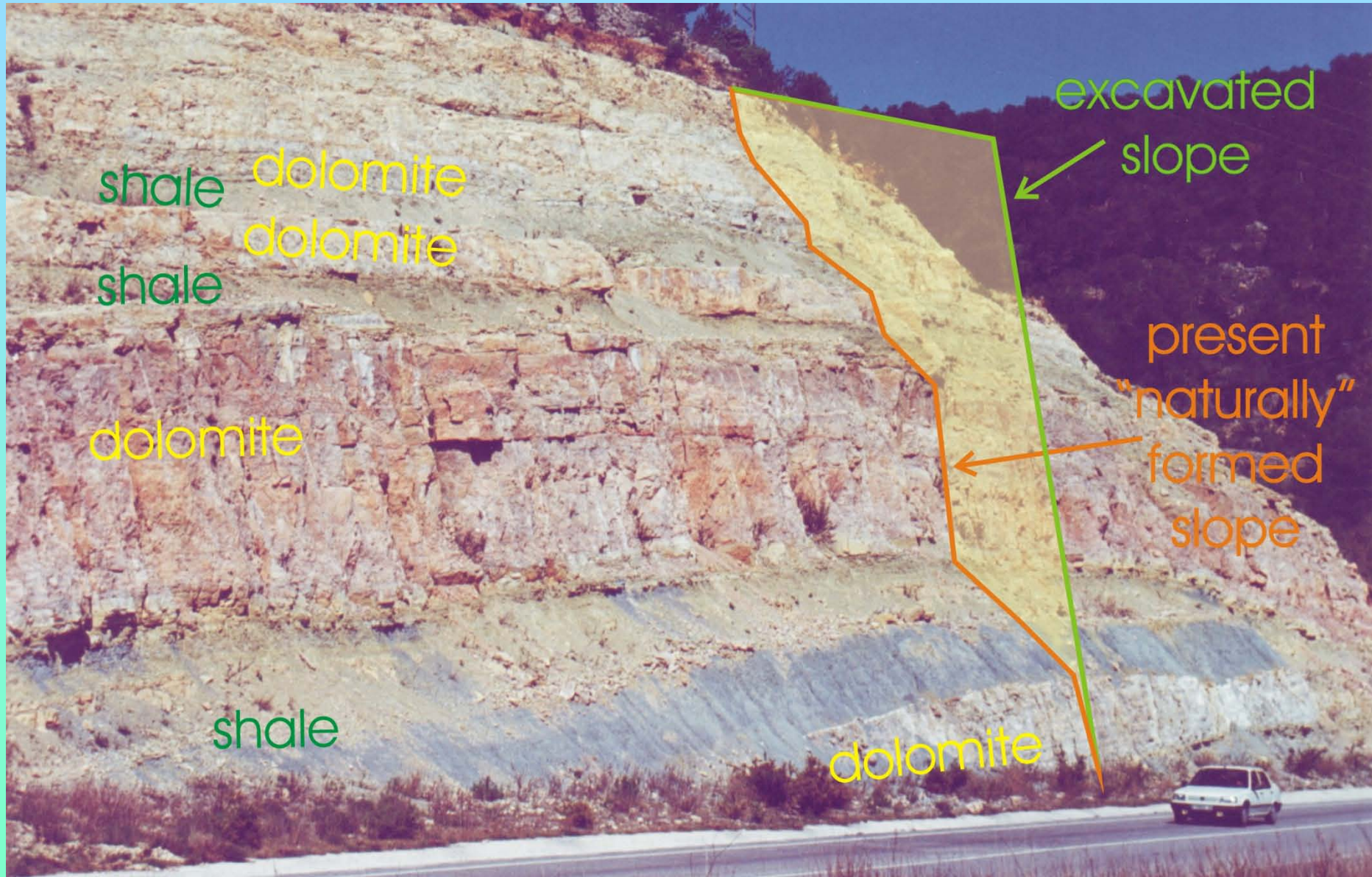

Let assume that a borehole has been made prior to excavation and that mass properties are known

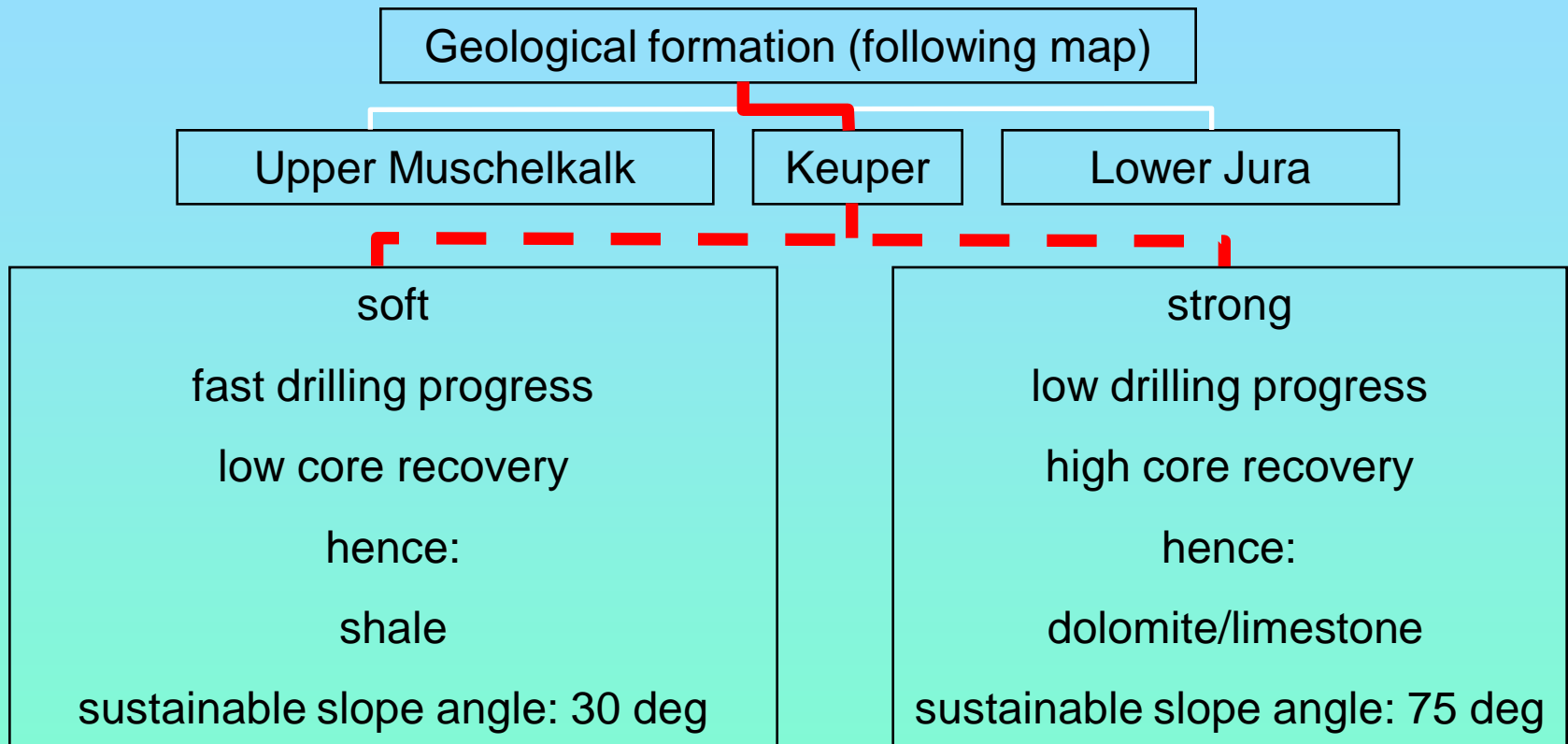

Hence: slope angle design fully automatic independent from interpreter

Let us assume that **no** borehole is made prior to excavation and mass properties are known: then from legend geological map (e.g. interbedded dolomite and shale layers):

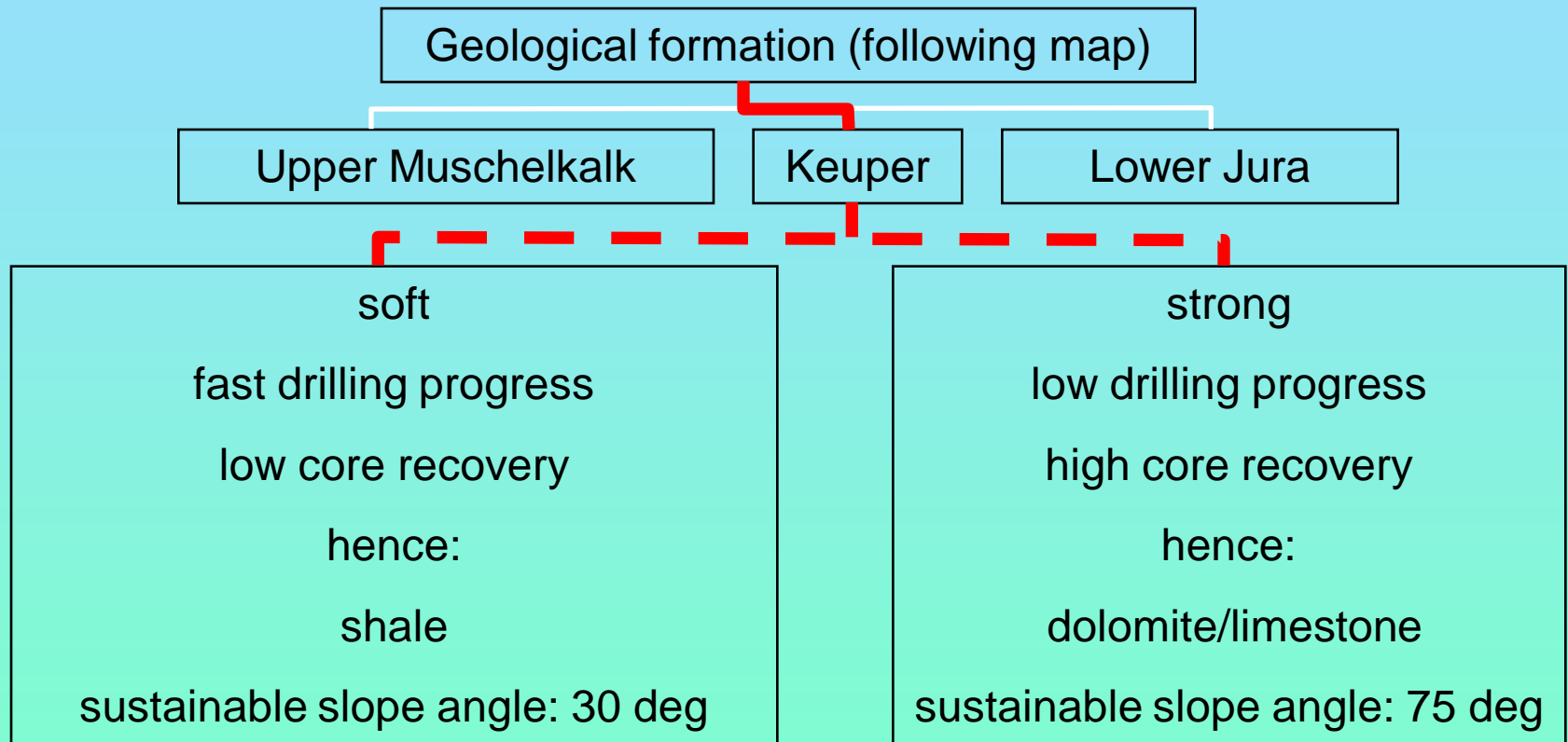

Hence:

Without borehole no exact slope heights for each unit can be established,

But

Overall slope designed on a 50/50% ratio of strong and weak layers would have given an overall slope angle of about 45 deg; far better in agreement with the final sustainable slope

- Misinterpretation of the subsurface geology or wrongly defined geotechnical units are inevitable
- To reduce the risks flow schemes could be developed that facilitate interpreter independent and controllable interpretation

Expectations from research

- Developments of standards for exchange of geodata (and thus also models)
- Uncertainty quantification

Future:

Is geodata going to be **required**?

YES

Is **more** geodata going to be **required**?

YES

Is **other** geodata required than at present?

YES

Can the **ease of use** of geodata be improved?

YES

Can geodata be made more **credible**?

YES

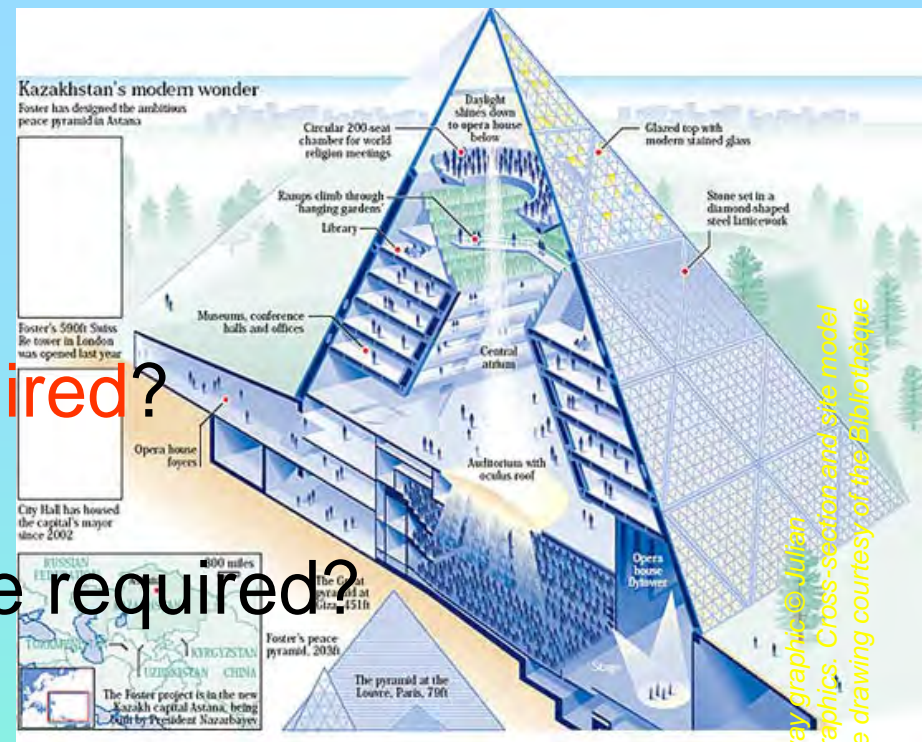

Text © Hugh Pearman. Cutaway graphics © Julian Osbaldestone/Sunday Times graphics. Cross-section and site model © Foster and Partners. Bouleée drawing courtesy of the Bibliothèque Nationale de France.

Settlement Rijswijkse Golfclub (2005) due to jacked tunnel from Ypenburg to The Hague.

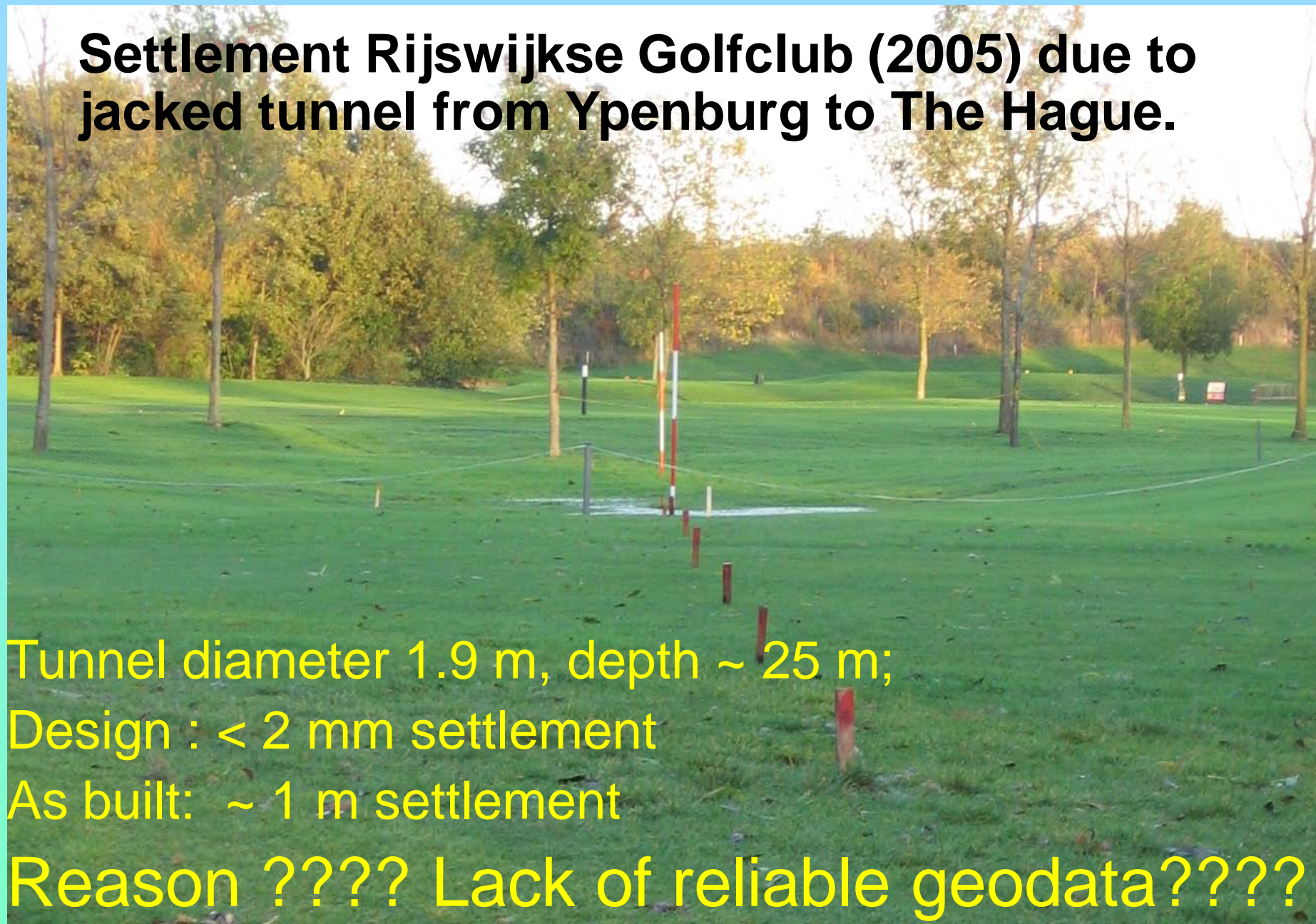

Tunnel diameter 1.9 m, depth ~ 25 m;

Design : < 2 mm settlement

As built: ~ 1 m settlement

Reason ????? Lack of reliable geodata????



Is there really that much improved ?